



TRUE MANUFACTURING CO., INC.
U.S.A. FOODSERVICE DIVISION

2001 East Terra Lane • O'Fallon, Missouri 63366-4434 • (636)240-2400
Fax (636)272-2408 • Toll Free (800)325-6152 • Intl Fax# (001)636-272-7546
Parts Dept. (800)424-TRUE • Parts Dept. Fax# (636)272-9471 • www.truemfg.com

Project Name: _____

Location: _____

Item #: _____ Qty: _____

Model #: _____

A/A #

SIS #

Model:
TMC-58-DS-HC

Milk Coolers:

Dual Sided, White Vinyl and Stainless Steel Exterior/Clear Aluminum Interior with Hydrocarbon Refrigerant



TMC-58-DS-HC

- ▶ True's commitment to using the highest quality materials and oversized refrigeration systems provides the user with colder product temperatures, and lower utility costs in an attractive, durable school milk cooler.
- ▶ Dual sided for convenient access to product from both sides of unit.
- ▶ Factory engineered, self-contained, capillary tube system using environmentally friendly R290 hydro carbon refrigerant that has zero (0) ozone depletion potential (ODP), & three (3) global warming potential (GWP).
- ▶ High capacity, factory balanced, forced-air refrigeration system maintains milk temperatures of 33°F to 38°F (.5°C to 3.3°C). Colder holding temperatures provide better tasting milk, increased sales and less product waste.
- ▶ Exterior - non-peel or chip white laminated vinyl front, sides, back and top; durable and permanent.
- ▶ All stainless steel self-service doors feature convenient drop front and "hold-open" flip-up top. Standard with door locks.
- ▶ Interior - attractive, NSF approved, clear coated aluminum liner with reinforced, stainless steel floor.
- ▶ Standard with heavy duty floor racks and convenient clean out drain.
- ▶ Designed to hold Sixteen 13"L x 13"D x 11 1/8"H (331 mm x 331 mm x 296 mm) milk crates.
- ▶ Entire cabinet structure is foamed-in-place using a high density, polyurethane insulation that has zero ozone depletion potential (ODP) and zero global warming potential (GWP).

ROUGH-IN DATA

Specifications subject to change without notice.
Chart dimensions rounded up to the nearest 1/8" (millimeters rounded up to next whole number).

Model	Doors	Capacity Crates	Crate Dimensions (inches) (mm)			Floor Racks	Cabinet Dimensions (inches) (mm)			HP	Voltage	Amps	NEMA Config.	Cord Length (total ft.) (total m)	Crated Weight (lbs.) (kg)
			W	D	H		W**	D†	H*						
TMC-58-DS-HC	4	16	13 331	13 331	11 1/8 296	3	58 1474	33 839	41 1/8 1058	1/2 N/A	115/60/1	2.7 N/A	5-15P	9 2.74	440 200

** Width does not include 1/8" (4 mm) each side for lid pins.

† Depth does not include 1" (26 mm) for front bumpers. Depth does not include 1" (26 mm) for rear bumpers.

* Height does not include 5 1/8" (130 mm) for castors.



APPROVALS:

AVAILABLE AT:

6/18-A

Printed in U.S.A.

Model:
TMC-58-DS-HC

Milk Coolers:

Dual Sided, White Vinyl and Stainless Steel Exterior/Clear Aluminum Interior with Hydrocarbon Refrigerant



STANDARD FEATURES

DESIGN

- True's commitment to using the highest quality materials and oversized refrigeration systems provides the user with colder product temperatures, and lower utility costs in an attractive, durable school milk cooler.

REFRIGERATION SYSTEM

- Factory engineered, self-contained, capillary tube system using environmentally friendly R290 hydro carbon refrigerant that has zero (0) ozone depletion potential (ODP), & three (3) global warming potential (GWP).
- High capacity, factory balanced refrigeration system that maintains cabinet temperatures of 33°F to 38°F (.5°C to 3.3°C) provide better tasting milk, increased sales and less product waste.
- State of the art, electronically commutated evaporator and condenser fan motors. ECM motors operate at higher peak efficiencies and move a more consistent volume of air which produces less heat, reduces energy consumption and provides greater motor reliability.
- Condensing unit accessed from behind back grill, slides out for easy cleaning and maintenance.

CABINET CONSTRUCTION

- Exterior - non-peel or chip white vinyl front, sides, back and top; durable and permanent. Stainless steel service doors.
- Interior - attractive, NSF approved, clear coated aluminum liner with reinforced, stainless steel floor. Standard with heavy duty floor racks.
- Insulation - entire cabinet structure is foamed-in-place using a high density, polyurethane insulation that has zero ozone depletion potential (ODP) and zero global warming potential (GWP).
- Welded, heavy duty steel frame rail, black powder coated for corrosion protection.
- Frame rail fitted with four (4) easy roll, 4" (102 mm) diameter swivel castors (front castors lock in place).
- Designed to hold Sixteen 13"L x 13"D x 11 1/8"H (331 mm x 331 mm x 296 mm) milk crates.

DOORS

- All stainless steel self-service doors feature convenient drop front and "hold-open" flip-up top. Door support bumpers standard.
- Door locks standard.
- Magnetic door gaskets of one piece construction, removable without tools for ease of cleaning.

MODEL FEATURES

- Exterior digital temperature display.
- Evaporator is epoxy coated to eliminate the potential of corrosion.
- Convenient clean out drain with 1/2" (13 mm) NPT-PVC drain plug.
- Listed under NSF/ANSI Standard 7 for the storage and/or display of packaged or bottled product.

ELECTRICAL

- Unit completely pre-wired at factory and ready for final connection to a 115/60/1 phase, 15 amp dedicated outlet. Cord and plug set included.



115/60/1
NEMA-5-15R

OPTIONAL FEATURES/ACCESSORIES

Upcharge and lead times may apply.

- 6" (153 mm) standard legs (mounting plates required).
- 6" (153 mm) seismic/flanged legs (mounting plates required).
- Corner bumpers.

PLAN VIEW

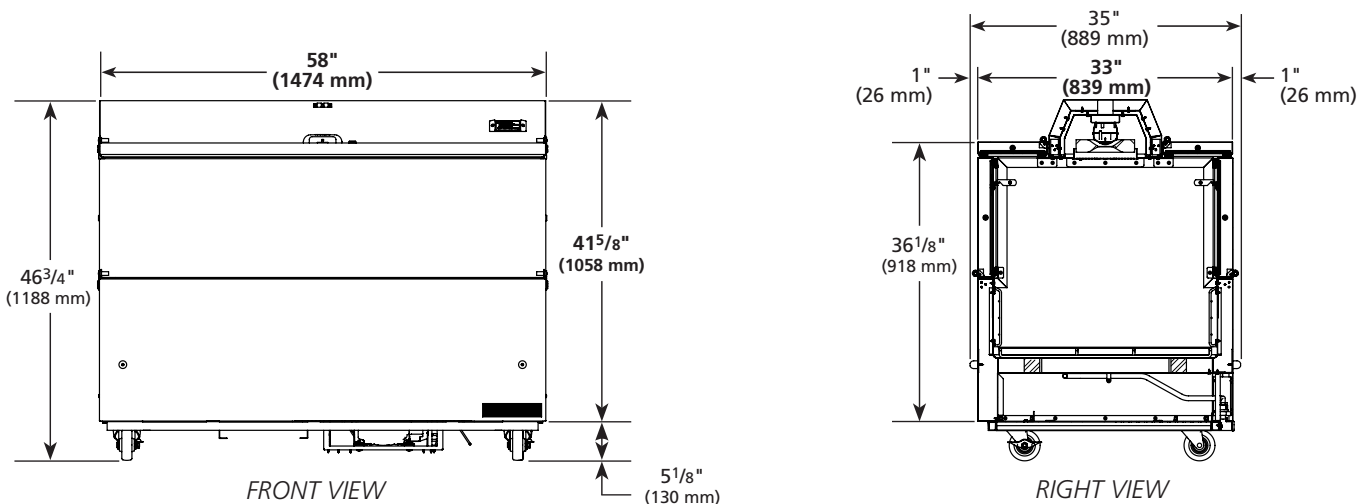

WARRANTY

Three year warranty on all parts and labor and an additional 2 year warranty on compressor. (U.S.A. only)

METRIC DIMENSIONS ROUNDED UP TO THE NEAREST WHOLE MILLIMETER

SPECIFICATIONS SUBJECT TO CHANGE WITHOUT NOTICE



Model	Elevation	Right	Plan	3D	Back
TMC-58-DS-HC	TFQ062E	TFQ062S	TFQ062P	TFQ0623	

TRUE MANUFACTURING CO., INC.

2001 East Terra Lane • O'Fallon, Missouri 63366-4434 • (636)240-2400 • Fax (636)272-2408 • Toll Free (800)325-6152 • Intl. Fax# (001)636-272-7546 • www.truefmfg.com